



**NÜVE SANAYİ MALZEMELERİ İMALAT VE  
TİCARET A.Ş.**

**BM 302 / BM 402**

**BS 302 / BS 402**

**BD402**

**WATER BATHS**

**USER'S MANUAL**



**Manufacturer:**

**NÜVE  
SANAYİ MALZEMELERİ  
İMALAT VE TİCARET A.Ş.**

**Esenboga Yolu, 22. Km.  
06287 ANKARA  
TURKEY  
Tel: 00 90 312 399 28 30(3 lines)  
Fax:00 90 312 399 21 97  
e-mail: [sales@nuve.com.tr](mailto:sales@nuve.com.tr)**

### **WARRANTY CERTIFICATE**

1. Nüve warrants that the equipment delivered is free from defects in material and workmanship. This warranty is provided for a period of two years. The warranty period begins from the delivery date.
2. Warranty does not apply to parts normally consumed during operation or general maintenance or any adjustments described in the operating instructions provided with the equipment.
3. Nüve does not accept any liability in the case where the goods are not used in accordance with their proper intent.
4. The warranty may not be claimed for damages incurred during the shipment, for damages resulting from improper handling or use, the defects in maintenance, negligence, bad functioning of auxiliary equipment, in the case of force majeure or accident and incorrect power supply.
5. In the event of failure, Nüve shall be under no liability for any injury, or any loss or damage as the result of the failure other than the guarantee conditions.

**BEFORE OPERATING THE INSTRUMENT THIS MANUAL SHOULD BE READ CAREFULLY.**

**INFORMATION CONTAINED IN THIS DOCUMENT IS THE PROPERTY OF NÜVE. IT MAY NOT BE DUPLICATED OR DISTRIBUTED WITHOUT HIS PERMISSION.**

**THE VALIDITY OF THE GUARANTEE IS SUBJECT TO THE OBSERVATION OF THE INSTRUCTIONS AND PRECAUTIONS DESCRIBED IN THIS MANUAL.**

<b>TABLE OF CONTENTS</b>	Page
<b>1. INTRODUCTION</b>	3
1.1. Use And Function	3
<b>2. TECHNICAL SPECIFICATIONS</b>	4
2.1. Technical Specifications Table	4
2.2. General Presentation	5
2.3. Optional Accessories	5
<b>3. INSTALLATION PROCEDURE</b>	6
3.1. Lifting and Transport	6
3.2. Unpacking	6
3.3. Environmental Conditions	6
3.4. Mains Supply	6
3.5. Positioning	6
3.6. Prior to Operation	7
3.6.1. Filling In Distilled Water / Liquid	7
3.6.2. Important Points	7
<b>4. OPERATING PRINCIPLES</b>	8
4.1. Switching On	8
4.2. Display And Control Panel	8
4.3. Programming Summary	14
4.4. Completion Of The Operation	16
<b>5. PERIODIC MAINTENANCE AND CLEANING</b>	17
5.1. Periodic Maintenance	17
5.2. Cleaning	17
<b>6. TROUBLESHOOTING</b>	17
6.1. General Troubleshooting	17
6.2. Errors Recognised By The Microprocessor Control System	18
<b>7. ELECTRICAL CIRCUIT DIAGRAMS</b>	19

## **1. INTRODUCTION**

### **1.1. Use And Function**

BM 302 / BM 402 series general purpose water baths and BS 302, BS 402 and BD 402 series refrigerated water baths are designed to carry out many applications in industrial and research laboratory environments.

The water bathes consistently provide good temperature control, temperature uniformity and stability between +5°C above the ambient temperature and 80°C for BM series, between 0°C and +80°C for BS series and between –30°C and +40°C for BD 402.

The water baths consist of a heater, a stainless steel tank, a pump (1 pump is standard for BM and BS series, 2 pumps are standard for BD 402) and a control unit.

The heater is placed on the bottom surface of the tank.

The cooling function is obtained by the evaporator placed inside the stainless steel tank for BS and BD series water baths.

The powerful circulation pump provides absolutely homogenous temperature distribution in the tank, the second circulation pump for BD 402 can be used to regulate the temperature of other equipment outside the water bath.

The microprocessor controlled system ensures reliable and accurate temperature control. It also provides easy and comfortable programming.

Programmable alarm limits assure safe working conditions.

**Do not operate the instrument for purposes other than main purpose.**

**The instrument is only to be used by authorised people after the user's manual has been read carefully. Only technical personnel can handle the product in case of a failure.**

**The BM, BS and BD series water baths are manufactured according to the following standards**

**EN 61010-1, EN 50081-1**

## 2. TECHNICAL SPECIFICATIONS

### 2.1. Technical Specifications Table

	BM 302	BM 402	BS 302	BS 402	BD 402
Temperature Range	Ambient Temp / 80 °C		0°C / 80°C	0°C / 80°C	-30°C/40°C
Temperature Sensor	Fe-Const		Pt – 100		
Control System	Programmable Microprocessor				
Temperature Set and Display Activity	0.1 °C				
Temperature Variation at 37 °C	<± 0.3 °C		<± 0.4 °C		<± 0.5 °C
Temperature Fluctuation	± 0.1 °C				
Timer	100 hours + Hold Position				
Useful capacity of Tank, liters	10	22	10	22	10
Power Consumption	750 W	1500 W	1250 W	2000 W	2000 W
Power Supply	230 V, 50 Hz				
Internal Material	Stainless Steel				
External Material	Epoxy-Painted Stainless Steel				
Internal Dimensions (WxDxH)mm	230 x 290 x 200	495 x 295 x 200	240x295x200	495x290x200	240x295x200
External Dimensions (WxDxH)mm	445 x 330 x 330	710 x 350 x 330	450x330x590	715x350x590	500x350x560
Packing Dimensions (WxDxH)mm	510 x 390 x 385	765 x 400 x 375	500x400x700	760x400x700	580x530x750
Net / Packed Weight kg.	11 / 12	22 / 26	26 / 28	45 / 50	40 / 45

## 2.2. General Presentation



1. Display And Control Panel
2. On / Off Switch
3. Power Supply Inlet And Fuses
4. RS 232 Connection Terminal
5. Drain Hose

## 2.3. Optional Accessories

- External circulation system for BM and BS series
- Control system with 9 memories and 9 steps
- High temperature option (100°C) for BM 302 / BM 402
- Tube rack and shelves
- Lids
- Lid with holes
- Nuveterm data control software and RS 232 interface

### **3. INSTALLATION PROCEDURE**

#### **3.1. Lifting And Transport**

All lifting and transport must be carried out using proper handling equipment. The water bath must be supported from underneath and never turned over.

#### **3.2. Unpacking**

Remove the packing cardboard box and the second nylon packing around the water bath. The below written are provided with the equipment, please check them;

- User's Manual
- Power cable

Check that no damage has occurred during transport,

#### **3.3. Environmental Conditions**

Please pay special attention to the followings,

- Indoor use only
- Room temperature from 5°C to 40 °C
- Humidity level % 80 up to 22 °C
- Maximum height 2000 m.
- The maximum performance is obtained between 15 °C and 25 °C.

#### **3.4. Mains Supply**

The water baths require 230 V, 50 / 60 Hz.

Please make sure that the supplied mains matches the required power ratings.

**Always plug the water baths to correctly grounded sockets.**

**A supply fitted with a circuit breaker should be used for protection against indirect contact in case of a isolation fault.**

#### **3.5. Positioning**

Lift the water bath underneath and carry it carefully to its place.

Balance the water bath on the four pedestals. If necessary, adjust the height of the pedestals.

Check the followings,

- The proposed site is suitable for users,
- The operator can follow up the water bath even he deals with something else.
- The water bath does not occupy the utilisation space of others or does not damage them.
- There is enough space from the cooling unit ventilation. Leave at least 20cm on the right side of the refrigerated water baths.
- Leave at least 20 cm. Free space between the equipment and wall.

### 3.6. Prior To Operation

#### 3.6.1. Filling in distilled water / liquid

- Fill the tank with distilled water / liquid which will not freeze at the set temperature and put the samples and add distilled water / liquid until the maximum line MAX (see diagram below). UNDESIRE PROBLEMS OCCUR IF YOU FILL LIQUID UP TO THE POINTS LOWER OR UPPER THAN THE MAX LINE.
- Please add distilled water/liquid if the distilled water / liquid level drops below the MAX line during the operation.
- Make sure that the filled liquid is not flammable or explosive at the operation temperature.
- 50 % distilled water and 50 % antifreeze mixture can be used 0°C and under 0°C operations.

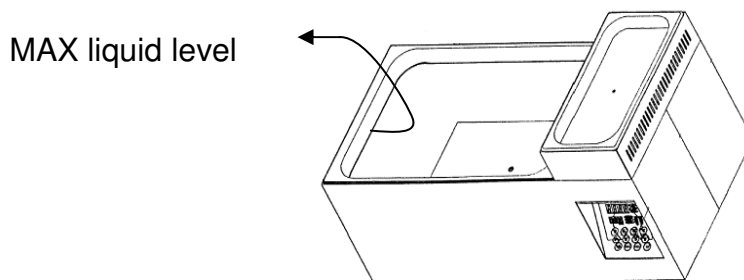

#### 3.6.2. Important Points

Plug the instrument in to a grounded socket.

Check the followings,

- Liquids are not heated in sealed containers,
- The boiling point of the samples are higher than the set temperature.
- The freezing points of the samples are lower than the set the temperature.
- The liquids which may expand during heating do not overflow from their containers,
- The set temperature does not destroy the structure of the samples,
- The vapor and gases which are generated during the operation are not harmful to human health or flammable or explosive,
- Make sure that the samples do not overflow from their containers when heated.
- Plug the power cable into a grounded socket.

**Note:** Never use explosive, flammable, acidic or toxic liquids. Read carefully the functions of the control panel.



## 4. OPERATING PRINCIPLES

### 4.1. Switching On

Push the On/Off switch.

See that the microprocessor control system activates.

Set the values and start the operation.

### 4.2. Display And Control Panel

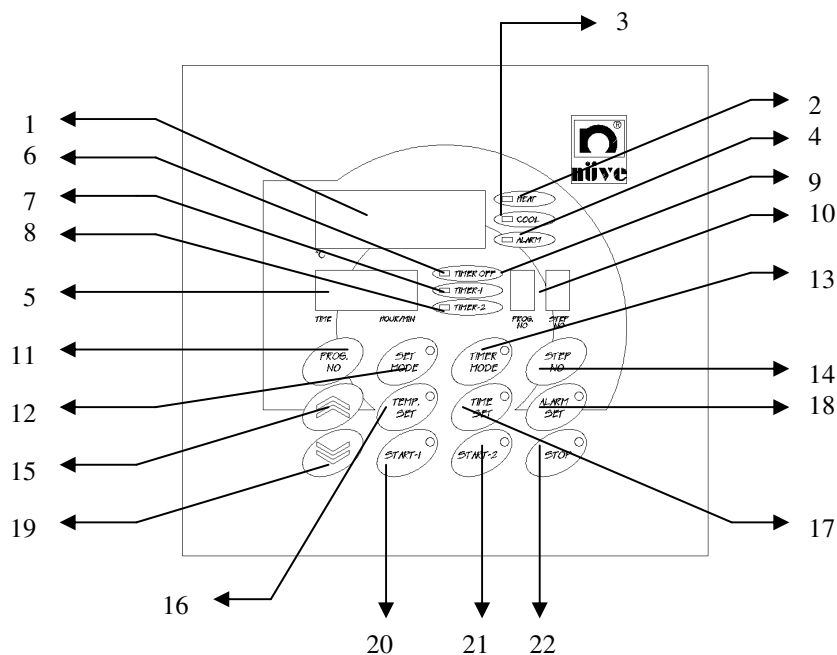

### 1. Temperature Display

This display shows,

- The temperature of the liquid inside the tank during the operation and the stand-by.
- The temperature and alarm set values during programming.
- The temperature and alarm set values during the control of set values.
- EoFF message in case of electrical interruption.
- Error codes in case of failure.
- “ nuVE ” when the instrument is powered on.

## **2. Heating Signal LED**

This LED flashes during the heating process.

## **3. Cooling Signal LED**

This LED flashes during the cooling process.

*THERE IS NO COOLING SIGNAL LED ON THE CONTROL PANEL OF BM302 / BM402*

## **4. Alarm Signal LED**

Alarm signal LED flashes continuously if the temperature exceeds the factory set alarm limits and in case of any failure detected by microprocessor control system.

## **5. Time Display**

This display shows :

- The time set value during programming.
- The elapsed time during the operation.
- “Hold” during programming and the operation when the timer off is selected.
- “Cont” during the control of set values.
- The time set value during the control of the set values.
- The repetition number if the Timer-2 is selected. (available for only nine-step programmable systems)
- The type of main PCB when the instrument is powered on.

## **6. Timer-Off LED**

The “Timer-Off” should be selected to operate the water bath at hold position. The “Hold” is shown at the Time Display and this LED remains on until the program is stopped manually by using the STOP key.

## **7. Timer - 1 LED**

If the Timer-1 option is selected, the timer counts up the time after the temperature has reached the lower value of alarm limit. When the program finishes, the water bath turns to stand-by position and the Timer - 1 LED flashes until the STOP key is pushed or the water bath is switched off.

## **8. Timer - 2 LED**

*AVAILABLE FOR ONLY NINE-STEP PROGRAMMABLE SYSTEMS*

If the timer - 2 is selected, this LED turns on and the timer starts to count up the time when the program is started. At the end of the program, if the stop button is not pushed the same program starts again and is repeated 20 times. At the end of the 20<sup>th</sup> repetition, the Timer - 2 LED flashes and the instrument turns to the stand-by position.

## 9. Program No Display

Nine - step programmable systems also have nine program memories.

This display shows :

- The number of the program which is operating.
- The number of the program during programming.
- The number of the program during the control of set values.
- The first letter of thermocouple type as “ F “ ( for BM 302 / BM 402 ) or “ P “ for (BS302 / BS 402 / BD 402 ) when the water bath is switched on.

Note : For the single-step programmable systems, this display always shows “ 1 “.

## 10. Step No Display

This display shows :

- The number of the step which is operating.
- The number of the step during programming.
- The number of the step to be checked during the control of the set values.
- The last letter of temperature sensor type as “ E “ ( for BM 302 / BM 402 ) or “ t “ ( BS 302 / BS402 / BD 402 ) when the water bath is powered on.

Note : For the single-step programmable systems, this display always shows “ p “.

## 11. Program No Key

*AVAILABLE FOR ONLY NINE-STEP PROGRAMMABLE SYSTEMS*

This key is used :

- To set the number of the program during programming.
- To call the program to be operated or checked.

The program number is increased by pressing the PROG NO key.

## 12. Set Mode Key And LED

The programming process is started by pushing this key. The LED turns on when the key is pushed.

The LED turns off when the TIMER MODE key is pressed and the set value is saved in the memory.

### **13. Timer Mode Key And LED**

The TIMER MODE key is pushed to select the type of timer.

The LED turns on when the key is pushed. Push the Value Increase key to change the type of timer.

The related LEDs of timer type will turn on during the selection. The LED turns off when the STEP NO or STOP key is pushed and the set value is saved in the memory.

### **14. Step No Key**

*AVAILABLE FOR ONLY NINE-STEP PROGRAMMABLE SYSTEMS*

This key is used :

- To set the number of the steps during programming
- To call a step to be checked.

The step number is increased by pressing the STEP NO key.

### **15. Value Increase Key**

This key is used to increase the set values in the related display.

Every push results in one unit increase. To rapidly increase the values, push the key continuously.

### **16. Temp. Set Key And LED**

This key is used to set the required temperature of the program. The LED turns on when the key is pushed.

To set the temperature value, push the TEMP SET key, then enter the required temperature value by using the VALUE INCREASE or VALUE DECREASE keys .

The LED turns off when the TIME SET key is pushed and the set value is saved in the memory.

### **17. Time Set Key And LED**

This key is used to set the required time of the program. The TIME SET key is pushed to set the time.

The LED turns on when the key is pushed. Use the VALUE INCREASE and VALUE DECREASE keys to adjust the time.

The LED turns off when the ALARM SET key is pushed and the set value is saved in the memory.

## **18. Alarm Set Key And LED**

This key is used to set the required alarm limits of the program.

The Alarm Set key is pushed to set the alarm limits. The LED turns on when the key is pushed.

The VALUE INCREASE and VALUE DECREASE are used to adjust the limits.

The LED turns off when the STOP key is pushed and the set value is saved in the memory.

## **19. Value Decrease Key**

This key is used to decrease the set values in the related display.

Every push results in one unit decrease. To rapidly decrease of the values, push the key continuously.

## **20. Start - 1 Key And LED**

The program can be started to run by pushing START-1 key. The LED of this key is on during the operation and turn off when the program is completed.

If the program is started with START-1 key, it is not cancelled by any electricity interruption and keeps running.

## **21. Start - 2 Key And LED**

The program can be started to run by pushing START-2 key.

The LED of this key turns on during the operation and turns off after the completion of the program.

If the program is started with START-2 key, the program may be cancelled by a electricity interruption as described below :

- a) If the measured temperature stays within the programmed alarm limits following the interruption, the program keeps running.
- b) If the measured temperature exceeds the programmed alarm limits following the interruption, the EoFF occurs. The operation of the program is cancelled, the " EoFF" error code and the liquid temperature inside the tank is shown on Temperature Display momentarily and sequentially and the user is warned by the audible alarm. The water bath turns back to stand-by position. To cancel the alarm, the program should be re-started or the STOP key should be pushed.

c) If the measured temperature exceeds the factory set alarm limits after the interruption, the EoFF position occurs. The operation is cancelled, the “EoFF” error code is shown on the Temperature Display continuously and the user is warned by an audible alarm. The instrument turns to stand-by position. The STOP key should be pushed to stop the alarm and re-start the water bath.













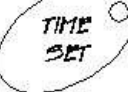

## **22. Stop Key And LED**

The STOP key is used to :

- Validate the parameters and save them in the memory during programming.
- Stop the running program manually.
- Cancel the alarm.













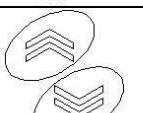

### 4.3. Programming Summary

#### Programming Of Single Step Systems

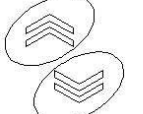

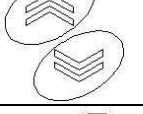
no	Steps of programming	°C display	TIME display
1	 Press the button	Water temperature in the tank	SEt
2	 Press the button	Water temperature in the tank	00.00 timer-1 LED is on
3	 Press this button to choose TIMER-1 or TIMER OFF.		
4	 Press this button to validate the entered value.		
5	 Press the button	<b>40.0</b> for BM 302 / 402 – BS 302 / 402, <b>0</b> for BD 402	00.00 or Hold
6	  Press these buttons to set the required temperature value ( for BM 302 / 402 between ambient temperature +5°C and 80°C, for BS 302 / 402 between 0°C and 80°C, for BD 402 between -30°C and 40°C. )		
7	 Press the button	Water temperature in the tank	00.00 or Hold
8	  Press these buttons to set the required time value ( 100 hours + hold position ) If the "Timer Off" is selected , there is no need to enter any time value		
9	 Press the button	000.5	00.00 or Hold
10	  Press these buttons to set the required alarm limit values. (between 0°C and 5°C)		
11	 Press this button to validate the entered values		
12	 or  Press this button to start the program		

Note: At the 3th step if "TIMER OFF" is selected , Hold appears on TIME display,  
"TIMER-1" is selected 00.00 appears on TIME display.

## Multiple Step Programming

no	Steps of programming	°C display	TIME display
1	 Press this button to choose the program no		
2	 Press this button to choose the step no		
3	 Press the button	Water temperature in the tank	SEt
4	 Press the button	Water temperature in the tank	00.00 timer-1 LED is on
5	 Press the button to choose TIMER-1, TIMER-2 or TIMER OFF		
6	 Press this button to validate the entered values		
7	 Press the button	<b>40.0</b> for BM 302 / 402 – BS 302 / 402, <b>0</b> for BD 402	00.00 or Hold
8	 Press these buttons to set the required temperature value ( for BM 302 / 402 between ambient temperature +5°C and 80°C, for BS 302 / 402 between 0°C and 80°C, for BD 402 between -30°C and 40°C. )		
9	 Press the button	Water temperature in the tank	00.00 or Hold
10	 Press these buttons to set the required time value ( 100 hours + hold position ) If the "Timer Off" is selected , there is no need to enter any time value		
11	 Press the button	000.5	00.00 or Hold
12	 Press these buttons to set the required alarm limit values. (between 0°C and 5°C)		
13	 Press this button to validate the entered values		
14	 Press this button increase step no and repeat the (7), (8), (9), (10), (11), (12), (13), (14) numbered steps to values for 9 programs		



15	 Press the button to increase program no and repeat between (2) and (15) numbered steps to values for 9 programs
16	 or  Press this button to start the program

**Note:**

- According to programming summary table, at the 5<sup>th</sup> step if "TIMER OFF" is selected, Hold appears on the TIME display, if "TIMER1" or "TIMER-2" is selected 00.00 appears on the TIME display.
- If "TIMER OFF" position is selected, the program operates only the first step temperature value until the program is stopped manually.
- Push the VALUE INCREASE key continuously for 5 seconds to see the set values while the water bath is running. First "Cont", and then "Set" are shown on the Time Display. Release the key when "Set" appears. The set values will be shown on the related displays and the LEDs of the related keys turn on sequentially. This cycle is repeated twice.
- To control the parameters for nine step of water baths push the STEP NO key during controlling.
- To control the parameters for other programs of instrument push the STEP NO key during controlling.

**4.4. Completion Of The Operation**

- See that the program is over.

**ATTENTION!! PLEASE BE AWARE OF THE LIQUID AMOUNT IN THE TANK DURING LONG OPERATIONS. PROTECT THE WATER BATH AGAINST THE FAILURES CAUSED BY THE LACK OF LIQUID.**

- Take the samples out. Be careful while handling the samples after the operation as they can be hot.
- Wipe the tank surface if needed after the tank has been completely emptied and when it is cold enough.
- You may leave the bath at stand-by or switch it off.

## **5. PERIODIC MAINTENANCE AND CLEANING**

### **5.1. Periodic Maintenance**

Please add distilled water/liquid if the distilled water / liquid level drops below the MAX line during the operation.

The water bath does not require any periodical maintenance which should be carried out by the operator. Please contact for your servicing and preventative maintenance requirements.

### **5.2. Cleaning**

After unplugging the equipment and the equipment is at the room temperature, wipe down the tank surface to remove any undesirable effects of the operation, for example spillage.

For the external body, you may use a piece of cloth. Mild detergent use is recommended to remove difficult dust and dirt.

Protect your tank against rust coming from outside.

**Please be aware of the undesirable effects of the chemicals and be careful while applying them.**

## **6. TROUBLESHOOTING**

### **6.1. General Troubleshooting**

The water bath fails to operate, check the followings,

- The On/Off switch is on,
- The plug is plugged-in properly,
- The plug is not defective,
- The mains supply is present.
- Fuses are sound,
- The installation of the plug is not defective,

The water bath does not heat, check the followings,

- The program is started.

The water bath does not cool, check the followings,

- The water pump operates,
- The ambient temperature does not exceed  $20 \pm 5^{\circ}\text{C}$  limits.

## **6.2. Errors Recognised By The Microprocessor Control System**

In case of failure during an operation, below written codes are shown on Temperature Display and the alarm sounds.

Err 1 : Thermocouple ends are broken.

Err 2 : There is an electronic fault.

Err 3 : The measured temperature value exceeds the limits of measurement range.

Err 4 : The thermocouple ends are connected in reverse or a 5°C difference has occurred during the operation due to a heating / cooling failure.

Err 6 : Timer-1 (or TIMER-2) is selected but no time value is set for the time.

EoFF: This error code appears if START-2 has been chosen and any probable power cut causes the temperature inside the liquid to go beyond the alarm limits.

**In case of any error, the program is stopped automatically and immediately.**

## 7. ELECTRICAL CIRCUIT DIAGRAMS

### BM 302

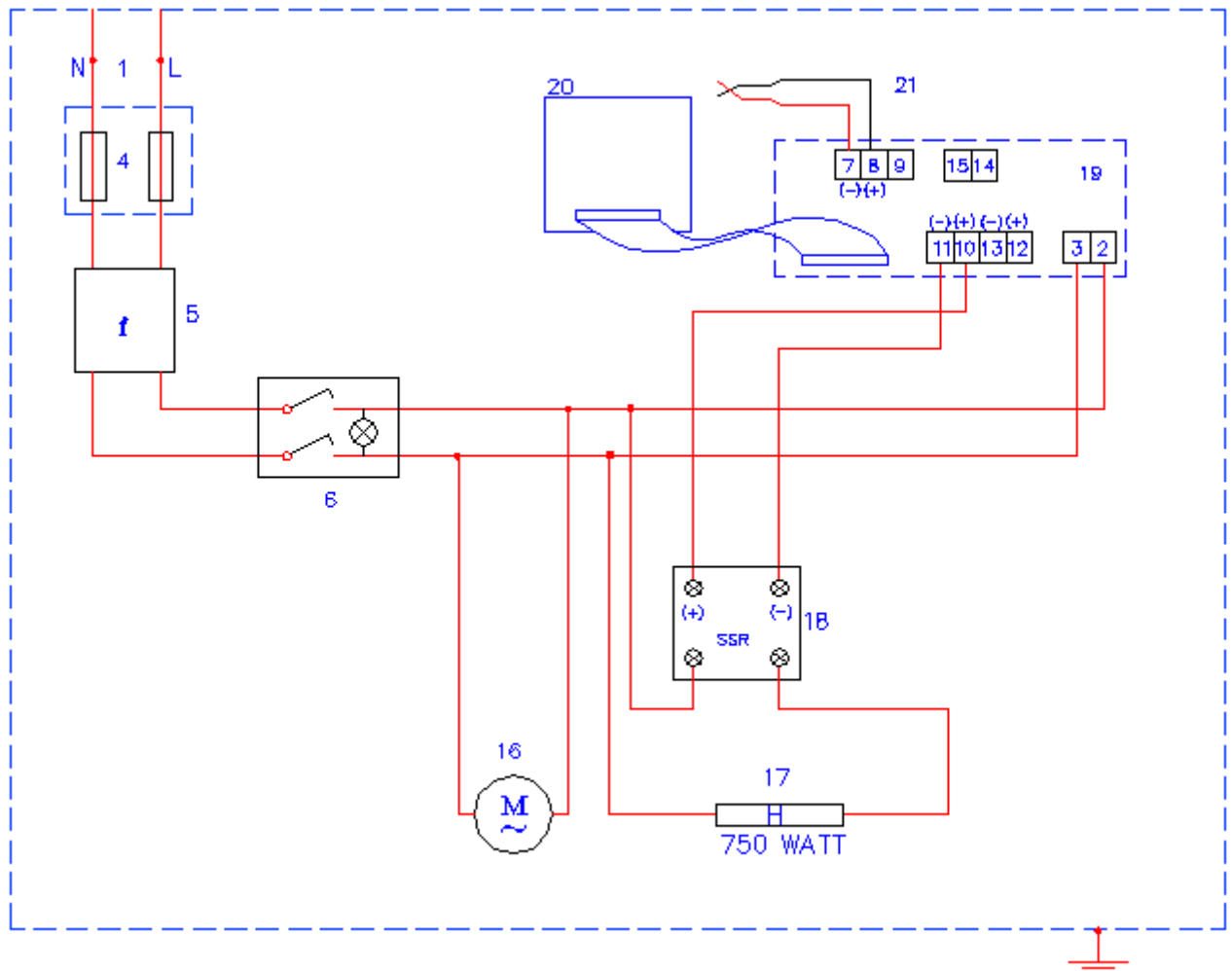

1. Mains supply connection clamp
2. Main PCB phase feeder clamp
3. Main PCB neutral feeder clamp
4. Fuses
5. EMC Filter
6. ON / Off switch
7. Fe-Const thermocouple (+) end clamp
8. Fe-Const thermocouple (-) end clamp
10. Heater relay outlet clamp (+)
11. Heater relay outlet clamp (-)
16. Circulation pump
17. Heater
18. SSR
19. Main PCB
20. Display and keyboard
21. Fe-const

## BM 402

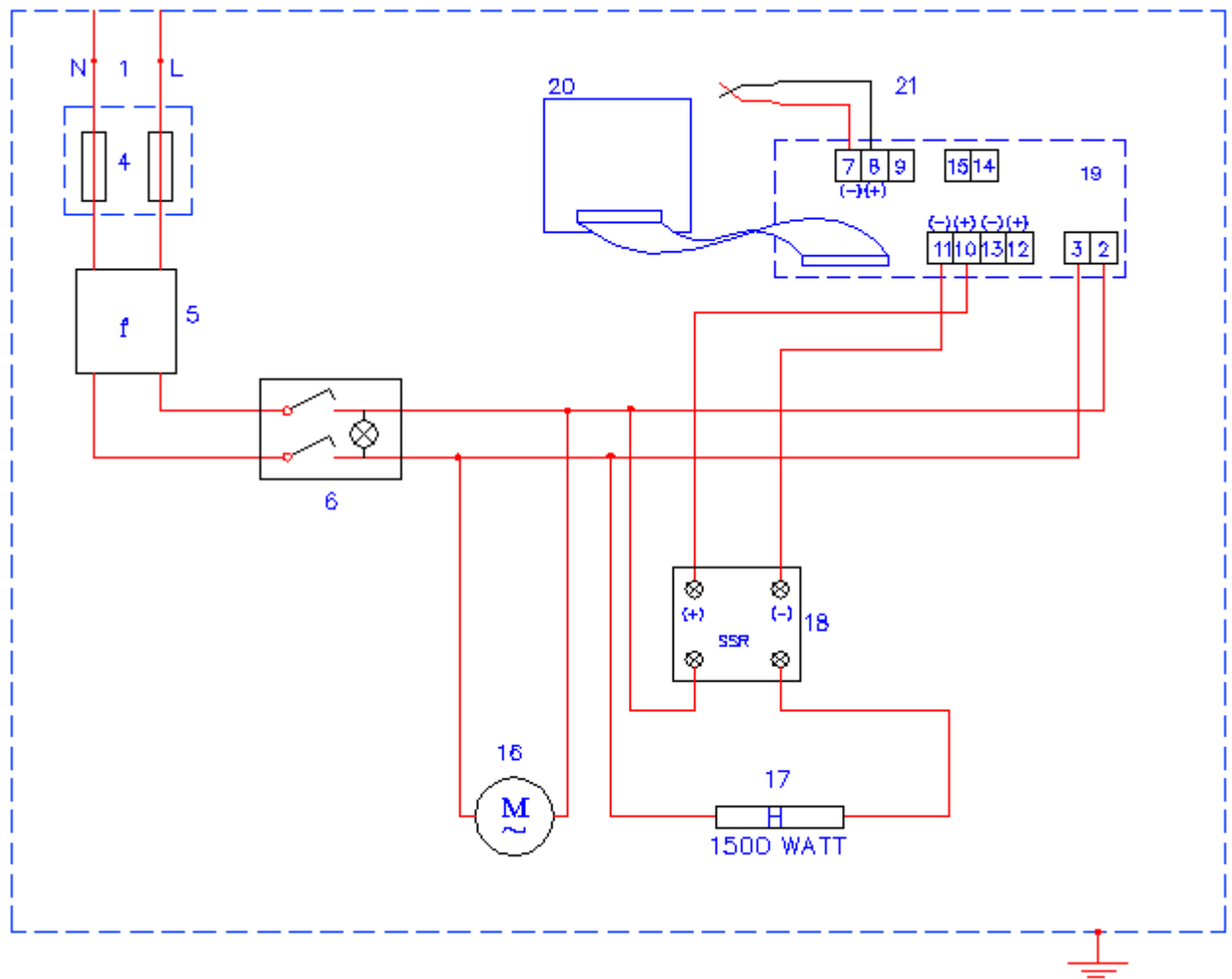

1. Mains supply connection clamp
2. Main PCB phase feeder clamp
3. Main PCB neutral feeder clamp
4. Fuses
5. EMC Filter
6. ON / Off switch
7. Fe-Const thermocouple (+) end clamp
8. Fe-Const thermocouple (-) end clamp
10. Heater relay outlet clamp (+)
11. Heater relay outlet clamp (-)
16. Circulation pump
17. Heater
18. SSR
19. Main PCB
20. Display and keyboard
21. Fe-const

## BS 302

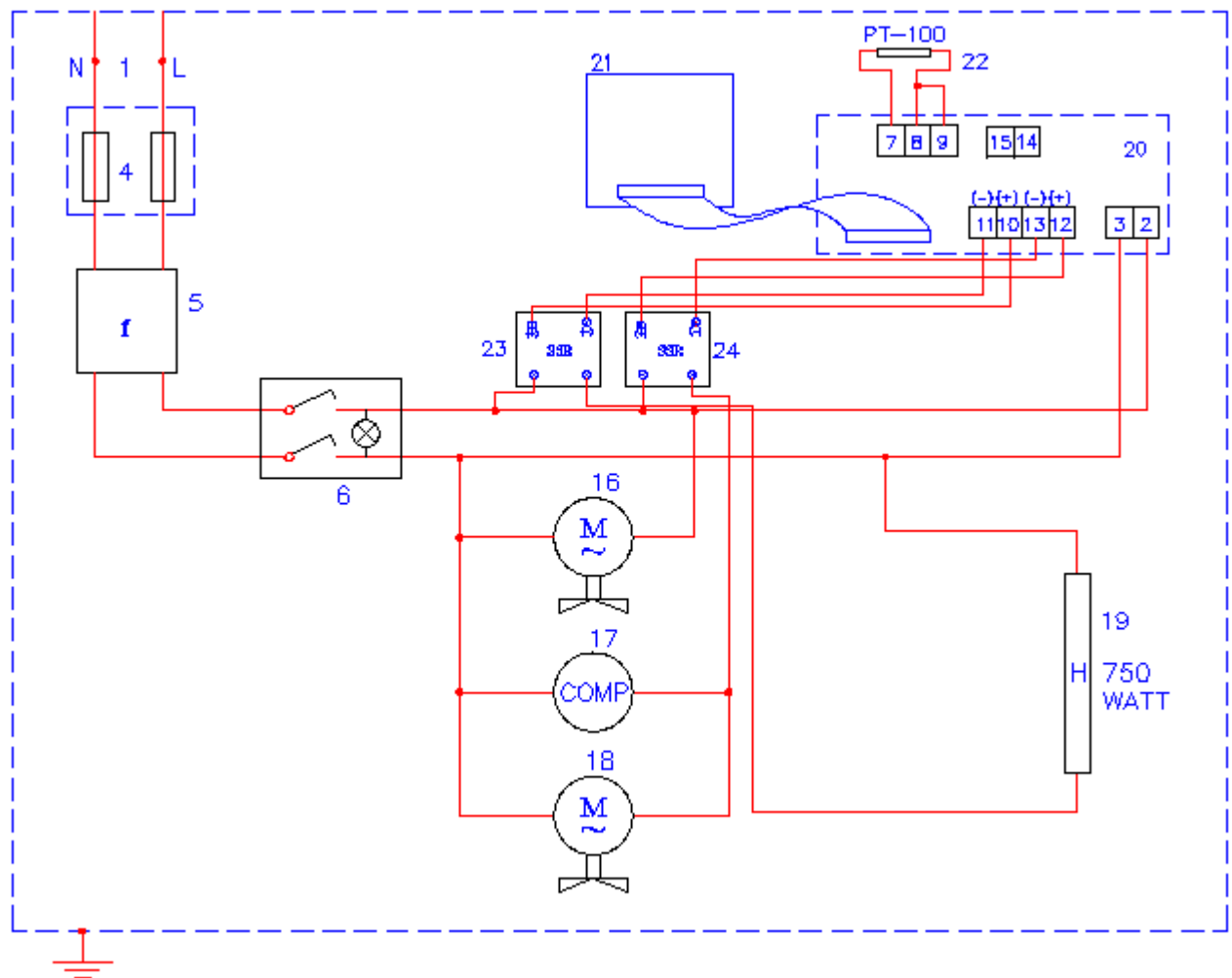

1. Mains supply connection clamp
2. Main PCB phase feeder clamp
3. Main PCB neutral feeder clamp
4. Fuses
5. EMC Filter
6. ON / Off switch
- 7-8-9. Pt – 100 end clamp
10. Heater relay outlet clamp (+)
11. Heater relay outlet clamp (-)
12. Cooling relay outlet clamp (+)
13. Cooling relay outlet clamp (-)
16. Circulation pump
17. Compressor
18. Condanser cooling fan
19. Heater
20. Main PCB
21. Display and keyboard
22. SSR (heating)
23. SSR (cooling)

## BS 402

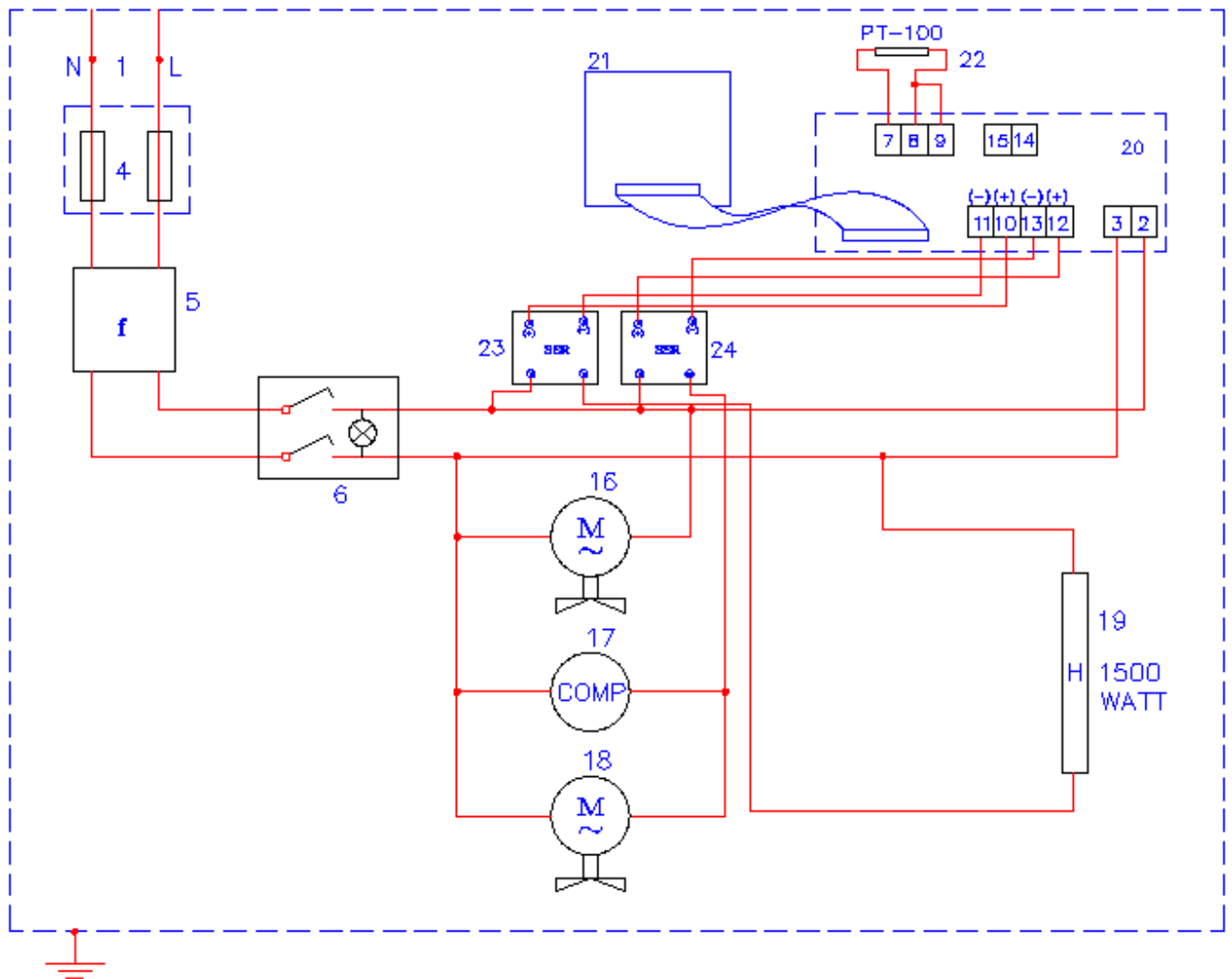

- |                                       |                                       |
|---------------------------------------|---------------------------------------|
| 1. Mains supply connection clamp      | 13. Main PCB cooling relay (-) outlet |
| 2. Main PCB phase clamp               | 16. Water pump                        |
| 3. Main PCB neutral clamp             | 17. Compressor                        |
| 4. Fuses                              | 18. Condenser cooling fan motor       |
| 5. EMC filter                         | 19. Heater                            |
| 6. On / Off switch                    | 20. Main PCB                          |
| 7. Temperature sensor (Pt-100) clamp  | 21. Display PCB                       |
| 10. Main PCB heating relay (+) outlet | 22. Pt - 100                          |
| 11. Main PCB heating relay (-) outlet | 23. SSR (heating)                     |
| 12. Main PCB cooling relay (+) outlet | 24. SSR (cooling unit)                |

## BD 402

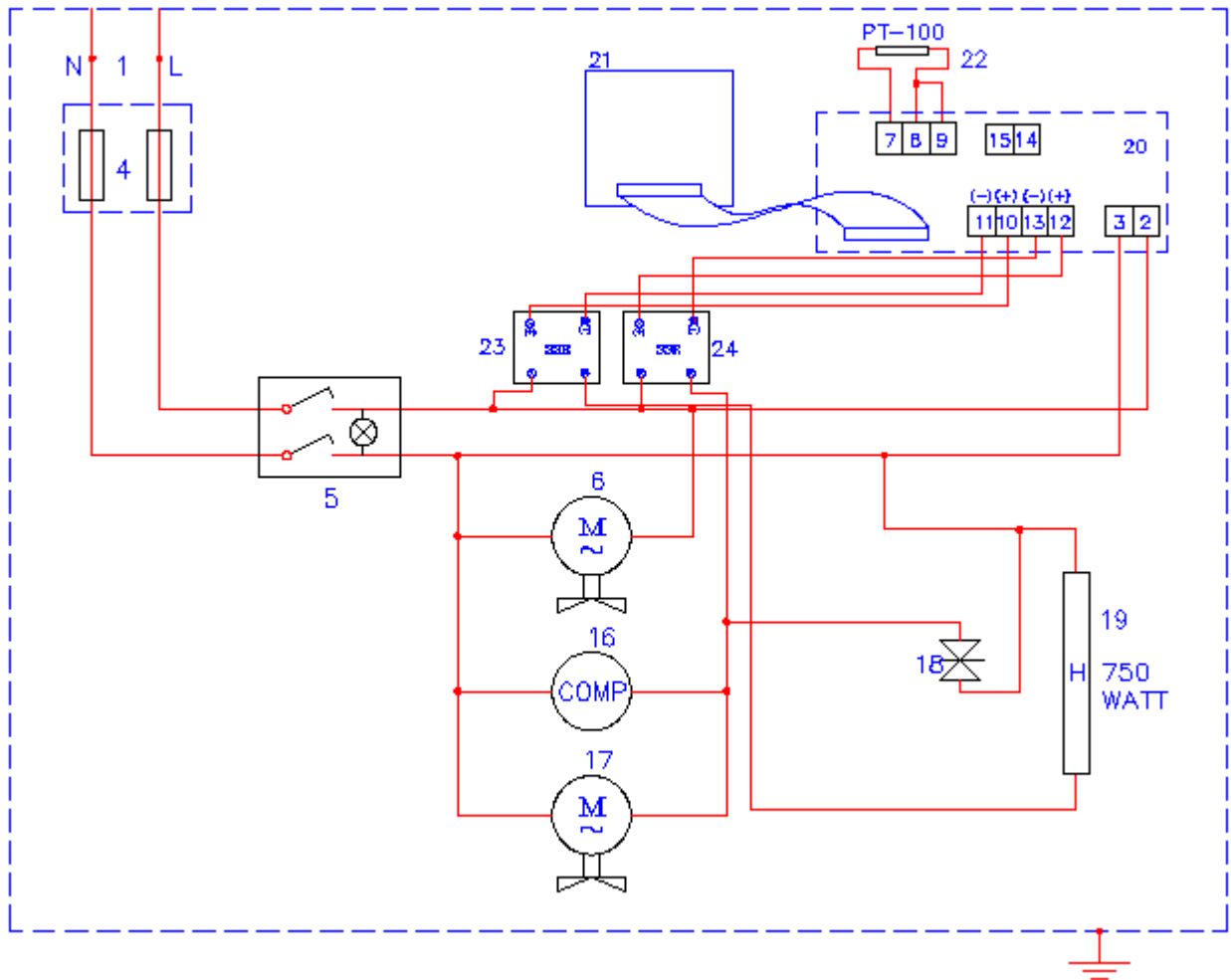

- |  |                                 |
|--|---------------------------------|
| 1. Mains supply connection clamp         | 16. Compressor                  |
| 2. Main PCB phase clamp                  | 17. Condenser cooling fan motor |
| 3. Main PCB neutral clamp                | 18. Gas solenoid valve          |
| 4. Fuses                                 | 19. Heater                      |
| 5. On / Off switch                       | 20. Main PCB                    |
| 6. Water pump                            | 21. Display PCB                 |
| 7-8-9. Temperature sensor (Pt-100) clamp | 22. Pt - 100                    |
| 10. Main PCB heating relay (+) outlet    | 23. SSR (heating)               |
| 11. Main PCB heating relay (-) outlet    | 24. SSR (cooling unit)          |
| 12. Main PCB cooling relay (+) outlet    | 25. External water pump         |
| 13. Main PCB cooling relay (-) outlet    |                                 |